

UPK40 01 355 BRF GRIS



APPLICATION:

Free-standing uplights, with direct and indirect emission of light.

BODY:



Anodized and extruded aluminium body and injected aluminium end cap, available in white, grey and aluminium colour. With 2 meter cables (2P+G) and plug.

OPTIC:

Asymmetric reflector in matt aluminium, with a high coefficient of reflection.

WIRING:

Luminaire wired with an electronic regulating ballast.

Voltage / Frequence	230V ~ 50Hz
Electrical Class	Classe I
N° of lamps x Wattage (W)	3x55
Lamp Type / Lamp Cap	TC-L/2G11
Efficiency (%) and Photometric Class	9C+74T
Index of protection (watertightness)	IP20
Resistance to Glow Wire (°C)	960
Mechanical impact protection index	
Cable max temperature (°C)	90
Product Certification Marks	 
Other Marks	
Electrical safety norm	EN 60598-2-1
CEM Norm	EN 61547, EN55015, EN61000-3-2
Other applicable norms:	2001/95/EC - Product General Safety 85/374CE - Civil Liability for Defective Products 1999/34/CE - Civil Liability for Defective Products

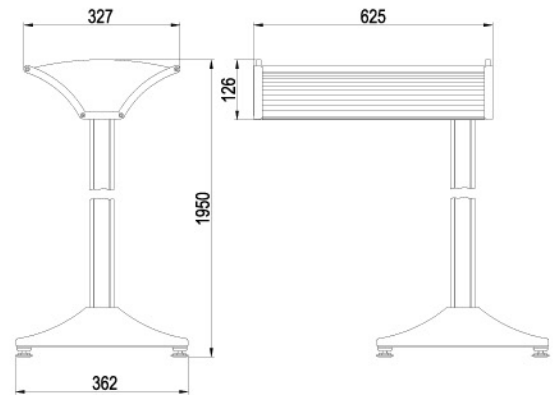

Polar Diagram

