

UPK30 01 236 BRF INOX



APPLICATION:

Free-standing uplights, with direct emission of light.

BODY:



Anodized and extruded aluminium body and injected aluminium end cap, available in white, grey and aluminium colour. With 2 meter cables (2P+G) and plug.

OPTIC:

Open upper-body, which assures indirect lighting.

WIRING:

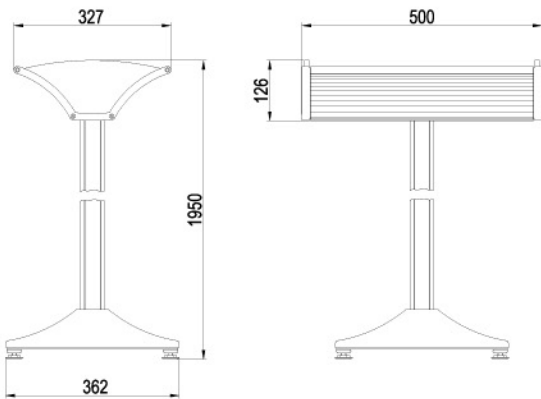
Luminaire wired with an electronic regulating ballast.

Voltage / Frequence	230V ~ 50Hz	
Electrical Class	Classe I	
N° of lamps x Wattage (W)	2x36	
Lamp Type / Lamp Cap	TC-L/2G11	
Efficiency (%) and Photometric Class	76,0	
Index of protection (watertightness)	IP20	
Resistance to Glow Wire (°C)	960	
Mechanical impact protection index		
Cable max temperature (°C)	90	
Product Certification Marks		
Other Marks		
Electrical safety norm	EN 60598-2-1	
CEM Norm	EN 61547, EN55015, EN61000-3-2	
Other applicable norms:	2001/95/EC - Product General Safety 85/374CE - Civil Liability for Defective Products 1999/34/CE - Civil Liability for Defective Products	

Polar Diagram

